



MASON INDUSTRIES, Inc.

Manufacturers of Vibration Control Products

350 Rabro Drive
Hauppauge, NY 11788
631/348-0282
FAX 631/348-0279

2101 W. Crescent Ave., Suite D
Anaheim, CA 92801
714/535-2727
FAX 714/535-5738

Info@Mason-Ind.com • www.Mason-Ind.com

1" 25mm and 2" 50mm DEFLECTION RESTRAINED SEISMIC SPRING MOUNTS with and without EXTENDED BASEPLATES

SLRSO & SLRSOEBP

DATA SHEET DS-224-3.1

SLRSO

1" 25mm Deflection B, 1 - 9 Springs

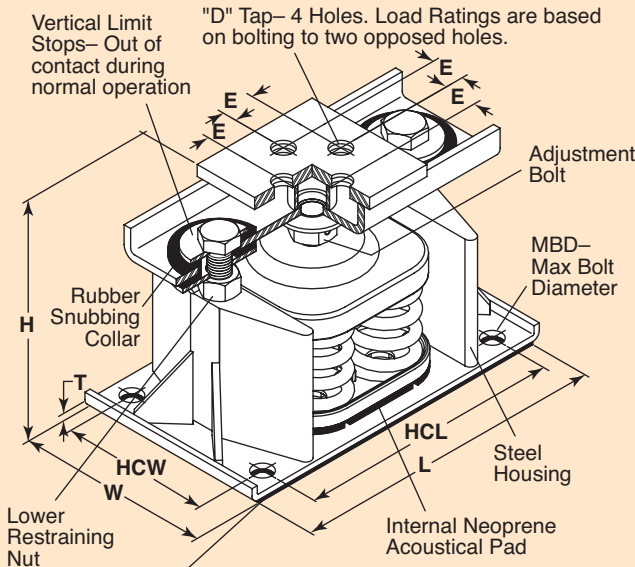

Non-Skid Pad is used in Non-Seismic zones only. Remove pad prior to bolting. Reduce published height by 1/8" if pad is removed.

Illustration above shows a SLRSO-4 housing with four C springs.

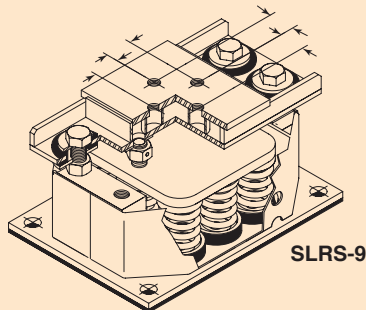

SLRS-9 has nine C springs and has closed sides. Not shown are SLRSO-B, which has one B spring and SLRSO-1, SLRSO-2 & SLRSO-6 which have one, two and six C springs respectively.

All springs have an additional travel to solid equal to 50% of the rated deflection.

Designs using these mounts to resist wind loads must be in accordance with ASCE 7-05.

OSHPD OPA-194 Rated Load Curves (lbs kg)

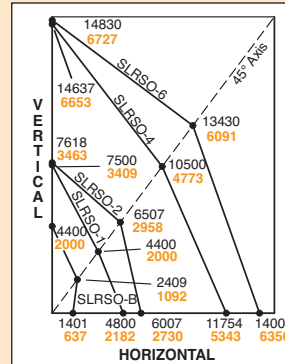

All mounts except SLRS-9 are awaiting OSHPD-194 approval. SLRS-9 has not been submitted.

Horizontal, Vertical and 45° plotted Ratings are California OSHPD submitted values having the OSHPD Anchorage Preapproval Number OPA-0194. Testing and calculations were performed to meet OSHPD criteria.

To use OSHPD submitted rated load curves:

- 1) Calculate Vertical and Horizontal Forces on mountings including translations and overturning moments.
- 2) Plot Horizontal and Vertical Loads. The intersection must fall within the area below the OSHPD curve.

TYPE SLRSO and SLRS RATINGS 1" 25mm Deflection Series

SLRSO Size	Rated Capacity (lbs) (kg)	Rated Defl (in) (mm)	Mount Constant (lbs/in) (kg/mm)	Max. Horiz. Housing Spring G Rating† Color
B-65	65 29	2.10 53	31 0.55	21.6 Brown
B-85	85 39	2.10 53	40 0.74	16.5 Wht/Blk
B-115	115 52	2.00 51	57 1.02	12.2 Silver
B-150	150 68	2.00 51	75 1.33	9.3 Orange
B-280	280 127	1.60 41	174 3.10	5.0 Green
B-450	450 204	1.31 33	344 6.18	3.1 Red
B-750	750 340	1.12 28	670 12.1	1.9 White
B-1000	1000 454	1.00 25	1000 18.2	1.4 Blue
1-1000	1000 454	1.00 25	1000 18.2	4.8 Black
1-1350	1350 612	1.00 25	1350 24.5	3.6 Yellow
1-1750	1750 794	1.00 25	1750 31.8	2.7 Black*
1-2100	2100 953	1.00 25	2100 38.1	2.3 Yellow
1-2385	2385 1082	1.00 25	2385 43.3	2.0 Yellow**
1-2650	2650 1202	1.00 25	2650 48.1	1.8 Red*
1-2935	2935 1331	1.00 25	2935 53.2	1.6 Red**
2-3500	3500 1588	1.00 25	3500 63.5	1.7 Black*
2-4200	4200 1905	1.00 25	4200 76.2	1.4 Yellow*
2-4770	4770 2164	1.00 25	4770 86.6	1.3 Yellow**
4-5400	5400 2449	1.00 25	5400 98.0	2.2 Yellow
4-7000	7000 3175	1.00 25	7000 127.0	1.7 Black*
4-8400	8400 3810	1.00 25	8400 152.4	1.4 Yellow*
4-9540	9540 4327	1.00 25	9540 173.1	1.2 Yellow**
4-10600	10600 4808	1.00 25	10600 192.3	1.1 Red*
4-11740	11740 5325	1.00 25	11740 213.0	1.0 Red**
6-12600	12600 5715	1.00 25	12600 228.6	1.1 Yellow*
6-14310	14310 6491	1.00 25	14310 259.6	1.0 Yellow**
6-15900	15900 7212	1.00 25	15900 288.5	0.9 Red*
6-17610	17610 7988	1.00 25	17610 319.5	0.8 Red**
SLRS Size				
9-18900	18900 8573	1.00 25	18900 342.9	‡ Yellow*
9-21465	21465 9736	1.00 25	21465 389.4	‡ Yellow**
9-23850	23850 10818	1.00 25	23850 432.7	‡ Red*

*with Red inner spring

**with Green inner spring

‡SLRS-9 under test

TYPE SLRSO and SLRS DIMENSIONS (inches and mm)

Type & Size	H	T	D	E	L	HCL	W	HCW	MBD
SLRSO-B	83/4 222	3/8 10	1/2 13	11/8 29	81/2 216	7 178	41/4 108	23/4 70	5/8 16
SLRSO-1	83/4 222	3/8 10	5/8 16	13/8 35	91/2 241	71/2 191	51/4 133	31/2 89	5/8 16
SLRSO-2	83/4 222	3/8 10	5/8 16	13/8 35	14 356	121/4 311	51/4 133	31/2 89	5/8 16
SLRSO-4	83/4 222	3/8 10	7/8 22	13/8 35	133/4 350	11 279	8 203	61/4 159	3/4 19
SLRSO-6	93/4 248	3/8 10	1 25	15/8 41	19 483	157/8 403	9 229	6 152	1 25
SLRS-9	93/4 248	5/8 16	1 25	2 51	18 457	153/4 400	13 330	103/4 273	1 25

†Housing load ratings expressed in G's are based on tests with bolted connections to steel top and bottom. SLRSO & SLRS housings require uniform support under entire base plate.

SPRING CHARACTERISTICS (inches and mm)

Spring Size	OD	Free Height	Ratio Kx/Ky	Ratio OD/OH
B	23/8 60	4 102	0.70-0.80	0.80
C	27/8 73	4 1/8 105	0.90-1.10	0.92

All springs have an additional travel to solid equal to 50% of the rated deflection.

Solid Spring Height = Free Height minus 1.5 times the Rated Deflection.

SLRSEBP (Extended Base Plate) 1" 25mm Deflection B, 1 - 9 Springs

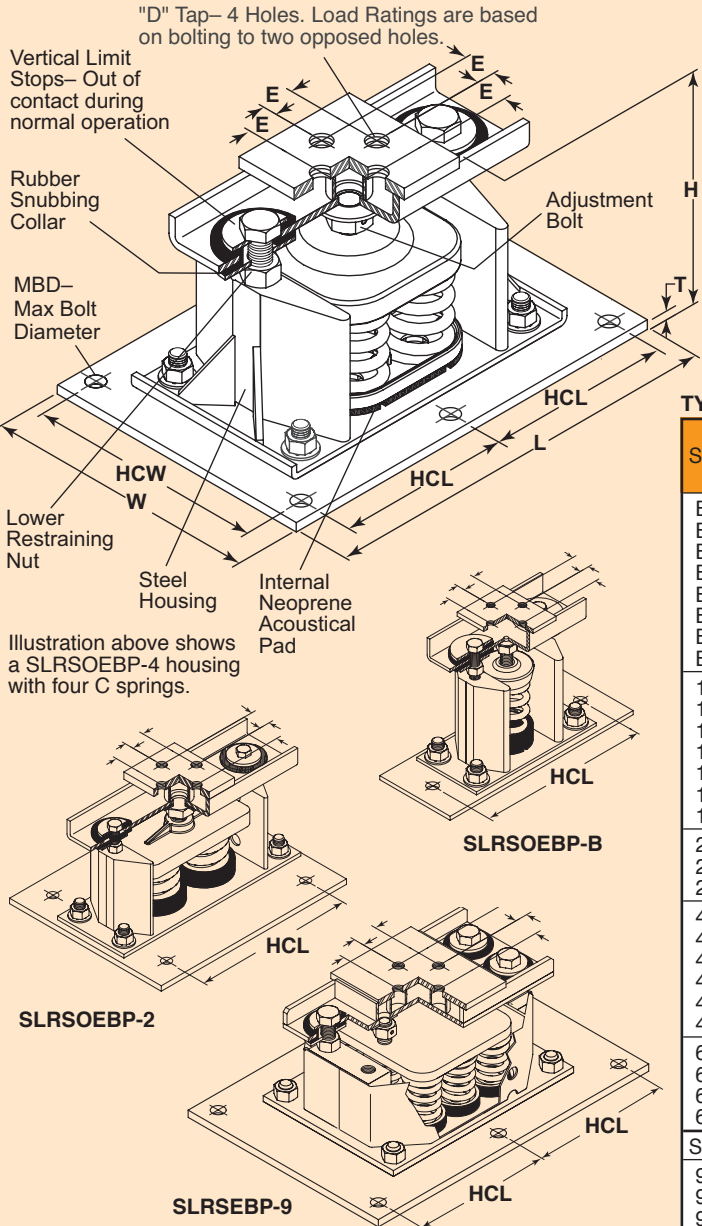

OSHPD OPA-194
Rated Load Curves (lbs kg)

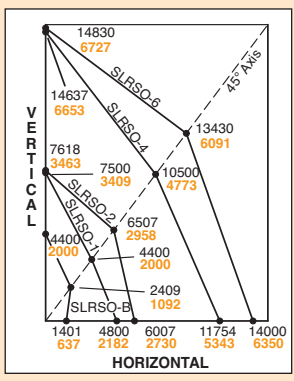

All mounts except SLRSEBP-9 are awaiting OSHPD-194 approval. SLRSEBP-9 has not been submitted.

Horizontal, Vertical and 45° plotted Ratings are California OSHPD submitted values having the OSHPD Anchorage Preapproval Number OPA-0194. Testing and calculations were performed to meet OSHPD criteria.

To use OSHPD submitted rated load curves:

- 1) Calculate Vertical and Horizontal Forces on mountings including translations and overturning moments.
- 2) Plot Horizontal and Vertical Loads. The intersection must fall within the area below the OSHPD curve.

TYPE SLRSEBP and SLRSEBP RATINGS 1" 25mm Deflection Series

SLRSEBP Size	Rated Capacity (lbs) (kg)	Rated Defl (in) (mm)	Mount Constant (lbs/in)(kg/mm)	Max. Horiz. G Rating Bolted to Concrete†	Spring Color
B-65	65 29	2.10 53	31 0.55	21.6	Brown
B-85	85 39	2.10 53	40 0.74	16.5	Wht/Blk
B-115	115 52	2.00 51	57 1.02	12.2	Silver
B-150	150 68	2.00 51	75 1.33	9.3	Orange
B-280	280 127	1.60 41	174 3.10	5.0	Green
B-450	450 204	1.31 33	344 6.18	3.1	Red
B-750	750 340	1.12 28	670 12.1	1.9	White
B-1000	1000 454	1.00 25	1000 18.2	1.4	Blue
1-1000	1000 454	1.00 25	1000 18.2	4.4	Black
1-1350	1350 612	1.00 25	1350 24.5	3.3	Yellow
1-1750	1750 794	1.00 25	1750 31.8	2.5	Black*
1-2100	2100 953	1.00 25	2100 38.1	2.1	Yellow
1-2385	2385 1082	1.00 25	2385 43.3	1.9	Yellow**
1-2650	2650 1202	1.00 25	2650 48.1	1.7	Red*
1-2935	2935 1331	1.00 25	2935 53.2	1.5	Red**
2-3500	3500 1588	1.00 25	3500 63.5	1.7	Black*
2-4200	4200 1905	1.00 25	4200 76.2	1.4	Yellow*
2-4770	4770 2164	1.00 25	4770 86.6	1.3	Yellow**
4-5400	5400 2449	1.00 25	5400 98.0	1.7	Yellow
4-7000	7000 3175	1.00 25	7000 127.0	1.3	Black*
4-8400	8400 3810	1.00 25	8400 152.4	1.1	Yellow*
4-9540	9540 4327	1.00 25	9540 173.1	1.0	Yellow**
4-10600	10600 4808	1.00 25	10600 192.3	0.9	Red*
4-11740	11740 5325	1.00 25	11740 213.0	0.8	Red**
6-12600	12600 5715	1.00 25	12600 228.6	0.8	Yellow*
6-14310	14310 6491	1.00 25	14310 259.6	0.7	Yellow**
6-15900	15900 7212	1.00 25	15900 288.5	0.65	Red*
6-17610	17610 7988	1.00 25	17610 319.5	0.6	Red**
SLRSEBP Size					
9-18900	18900 8573	1.00 25	18900 342.9	‡	Yellow*
9-21465	21465 9736	1.00 25	21465 389.4	‡	Yellow**
9-23850	23850 10818	1.00 25	23850 432.7	‡	Red*

*with Red inner spring **with Green inner spring ‡SLRSEBP-9 under test

†Horizontal load ratings expressed in G's are based on calculations with bolted connections to steel on top and concrete inserts on bottom. SLRSEBP housings require uniform support under entire base plate.

TYPE SLRSEBP and SLRSEBP DIMENSIONS (inches and mm)

Type & Size	H	T	D	E	L	HCL	W	HCW	MBD
SLRSEBP-B	9 229	3/8 10	1/2 13	11/8 29	13 330	101/2 267	5 127	-	5/8 16
SLRSEBP-1	9 229	3/8 10	5/8 16	13/8 35	10 254	8 203	10 254	8 203	5/8 16
SLRSEBP-2	9 229	3/8 10	5/8 16	13/8 35	14 1/2 368	11 280	12 305	9 229	3/4 19
SLRSEBP-4	9 229	3/8 10	7/8 22	13/8 35	19 482	8 203	14 356	11 280	3/4 19
SLRSEBP-6	10 1/4 260	1/2 13	1 25	15/8 41	27 686	12 305	15 381	12 305	1 25
SLRSEBP-9	10 1/4 260	5/8 16	1 25	2 51	27 686	12 305	19 483	16 406	1 25

SPRING CHARACTERISTICS (inches and mm)

Spring Size	Free OD	Free Height	Ratio Kx/Ky	Ratio OD/OH
B	23/8 60	4 102	0.70-0.80	0.80
C	27/8 73	4 1/8 105	0.90-1.10	0.92

All springs have an additional travel to solid equal to 50% of the rated deflection.

Solid Spring Height = Free Height minus 1.5 times the Rated Deflection.

Designs using these mounts to resist wind loads must be in accordance with ASCE 7-05.

SLRSOEBP (Extended Base Plate)

2" 50mm Deflection B, B2 & C2, 2-C2, 4-C2, 6-C2 & 9-C2 Springs

"D" Tap- 4 Holes. Load Ratings are based on bolting to two opposed holes.

Vertical Limit Stops- Out of contact during normal operation

Rubber Snubbing Collar

MBD- Max Bolt Diameter

Lower Restraining Nut

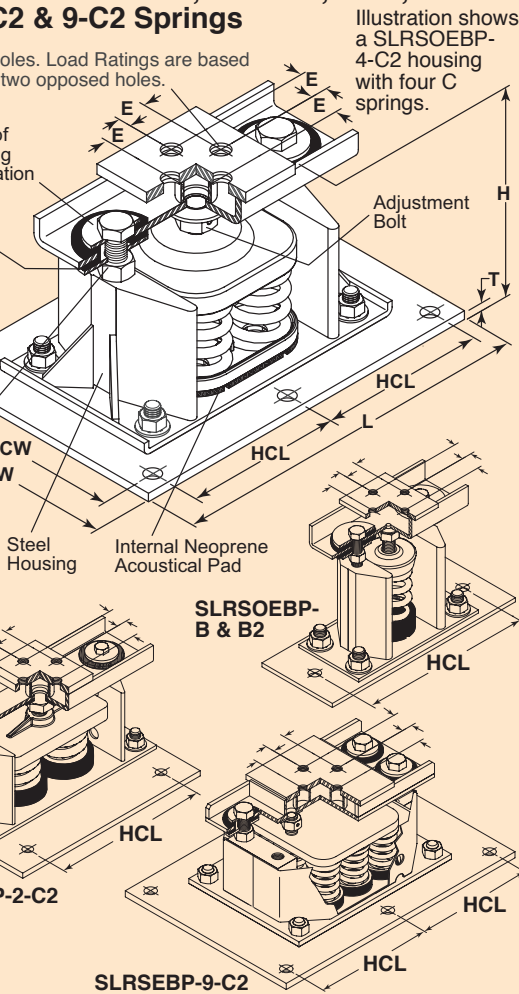

Illustration shows a SLRSOEBP-4-C2 housing with four C springs.

TYPE SLRSOEBP and SLRSEBP RATINGS 2" 50mm Deflection Series

SLRSOEBP Size	Rated Capacity (lbs) (kg)	Rated Defl (in) (mm)	Mount Constant (lbs/in)(kg/mm)	Max. Horiz. G Rating Bolted to Concrete†	Spring Color	
B-20	20	9	2.40 61	8 0.15	70.0	Tan
B-26	26	12	2.18 55	12 0.22	53.9	Wht/Brown
B-35	35	16	2.20 56	16 0.29	40.0	Purple
B-50	50	23	2.20 56	24 0.41	28.0	Wht/Red
B-65	65	29	2.10 53	31 0.55	21.6	Brown
B-85	85	39	2.10 53	40 0.74	16.5	Wht/Blk
B-115	115	52	2.00 51	57 1.02	12.2	Silver
B-150	150	68	2.00 51	75 1.33	6.8	Orange
B2-210	210	95	2.12 54	99 1.76	9.3	Silver
B2-290	290	132	2.00 51	144 2.59	4.9	Blue
B2-450††	450	204	2.00 51	224 4.00	3.2	Tan
B2-680††	680	308	2.00 51	340 6.04	2.1	Gray
C2-125	125	57	2.50 64	50 0.89	35.5	Purple
C2-170	170	77	2.40 61	70 1.26	26.1	Brown
C2-210	210	95	2.30 58	90 1.64	21.1	Red
C2-260	260	118	2.20 56	120 2.11	17.1	White
C2-330	330	150	2.00 51	165 2.94	13.5	Black
C2-460	460	209	2.00 51	230 4.10	9.6	Blue
C2-610	610	277	2.00 51	305 5.43	7.3	Green
C2-880††	880	399	2.00 51	440 7.82	5.0	Gray
C2-1210††	1210	549	2.00 51	605 10.8	3.7	Silver
C2-1540††	1540	699	2.00 51	770 13.7	2.9	Gray*
C2-1870††	1870	848	2.00 51	935 16.6	2.4	Silver*
2-C2-340	340	154	2.40 61	140 2.52	17.7	Brown
2-C2-420	420	191	2.30 58	180 3.29	14.3	Red
2-C2-520	520	236	2.20 56	240 4.21	11.6	White
2-C2-660	660	299	2.00 51	330 5.86	9.1	Black
2-C2-920	920	417	2.00 51	460 8.18	6.5	Blue
2-C2-1220	1220	553	2.00 51	610 10.8	4.9	Green
2-C2-1760††	1760	798	2.00 51	880 15.7	3.4	Gray
2-C2-2420††	2420	1098	2.00 51	1210 21.5	2.5	Silver
2-C2-3080††	3080	1397	2.00 51	1540 27.4	1.9	Gray*
2-C2-3740††	3740	1696	2.00 51	1870 33.2	1.6	Silver*
4-C2-4840††	4840	2195	2.00 51	2420 43.0	1.9	Silver
4-C2-6160††	6160	2794	2.00 51	3080 54.8	1.5	Gray*
4-C2-7480††	7480	3393	2.00 51	3740 66.5	1.2	Silver*
6-C2-7260††	7260	3293	2.00 51	3630 64.6	1.4	Silver
6-C2-9240††	9240	4191	2.00 51	4620 82.2	1.1	Gray*
6-C2-11220††	11220	5089	2.00 51	5610 99.8	0.9	Silver*
SLRSEBP Size						
9-C2-13860††	13860	6287	2.00 51	6930 123.2	±	Gray*
9-C2-16830††	16830	7634	2.00 51	8415 149.7	±	Silver*

*with Red inner spring

±SLRSEBP-9 under test

SLRSOEBP-B & B2 have one B or B2 spring, SLRSOEBP-2-C2 has two C2 springs and SLRSEBP-9-C2 has nine C2 springs and has closed sides. Not shown is SLRSOEBP-C2, which has one C2 spring and SLRSOEBP-6-C2 which has six C2 springs.

OSHPD OPA-194 Rated Load Curves (lbs kg)

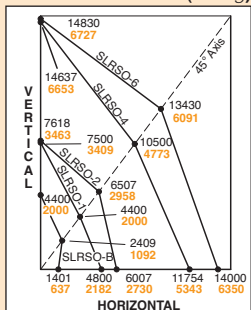

All mounts except SLRSEBP-9-C2 are awaiting OSHPD-194 approval. SLRSEBP-9-C2 has not been submitted.

Horizontal, Vertical and 45° plotted Ratings are California OSHPD submitted values having the OSHPD Anchorage Preapproval Number OPA-0194. Testing and calculations were performed to meet OSHPD criteria.

To use OSHPD submitted rated load curves:

- 1) Calculate Vertical and Horizontal Forces on mountings including translations and overturning moments.
- 2) Plot Horizontal and Vertical Loads. The intersection must fall within the area below the OSHPD curve.

†Horizontal load ratings expressed in G's are based on calculations with bolted connections to steel on top and concrete inserts on bottom. SLRSOEBP housings require uniform support under entire base plate.

††Published ratings allow minimum 25% additional travel to solid. For a full 50% specified minimum use the following ratings:

Size	Derated Capacity (lbs) (kg)	Defl. (in) (mm)	Size	Derated Capacity (lbs) (kg)	Defl. (in) (mm)
B2-450	410	186 1.83 46	2-C2-3740	3120 1415	1.67 42
B2-680	565	256 1.67 42	4-C2-4840	4040 1833	1.67 42
C2-880	800	363 1.82 46	4-C2-6160	5145 2334	1.67 42
C2-1210	1010	458 1.67 42	4-C2-7480	6245 2833	1.67 42
C2-1540	1285	583 1.67 42	6-C2-7260	6060 2749	1.67 42
C2-1870	1560	708 1.67 42	6-C2-9240	7715 3500	1.67 42
2-C2-1760	1600	726 1.67 42	6-C2-11220	9370 4250	1.67 42
2-C2-2420	2020	916 1.67 42	9-C2-13860	11570 5248	1.67 42
2-C2-3080	2570	1166 1.67 42	9-C2-16830	14050 6373	1.67 42

SPRING CHARACTERISTICS (inches and mm)

Spring Size	OD	Free Height	Ratio Kx/Ky	Ratio OD/OH
B	23/8 60	4 102	0.55-0.65	0.95-1.00
B2	23/8 60	4 1/2 114	0.80-0.90	1.19-1.48
C2	27/8 73	5 127	0.63-0.85	0.96-1.15

All springs without "†††" have an additional travel to solid equal to 50% of the rated deflection.

Solid Spring Height = Free Height minus 1.5 times the Rated Deflection.

Designs using these mounts to resist wind loads must be in accordance with ASCE 7-05.

TYPE SLRSOEBP and SLRSEBP DIMENSIONS (inches and mm)

Type & Size	H	T	D	E	L	HCL	W	HCW	MBD
SLRSOEBP-B & B2	9	3/8	1/2	11/8	13	10 1/2	5	-	5/8
SLRSOEBP-C2	9	3/8	5/8	13/8	10	8	10	8	5/8
SLRSOEBP-2-C2	229	10	16	35	254	203	254	203	16
SLRSOEBP-4-C2	9	3/8	5/8	13/8	14 1/2	11	11	9	3/4
SLRSOEBP-6-C2	9	3/8	7/8	13/8	19	8	14	11	3/4
SLRSEBP-9-C2	229	10	22	35	482	203	356	280	19
SLRSOEBP-101/4	101/4	1/2	1	15/8	27	12	15	12	1
SLRSEBP-101/4	260	13	25	41	686	305	381	305	25
SLRSEBP-101/4	260	16	25	51	686	305	483	406	25